

WWW.MARDOCONHECIMENTO.COM.BR

Atividades

Canção

Pini Abacaxi



Autora: Iracema Cerdán Zavaleta Galves

Revisão: Elizabeth Simplício de Oliveira

Diagramação: Canva

Publicação: Janeiro/2025



<https://www.instagram.com/mardoconhecimento/>



<https://pt-br.facebook.com/MarDoConhecimentoNoFace/>



<https://youtube.com/c/MardoConhecimento>

PINTE O ...

TREM

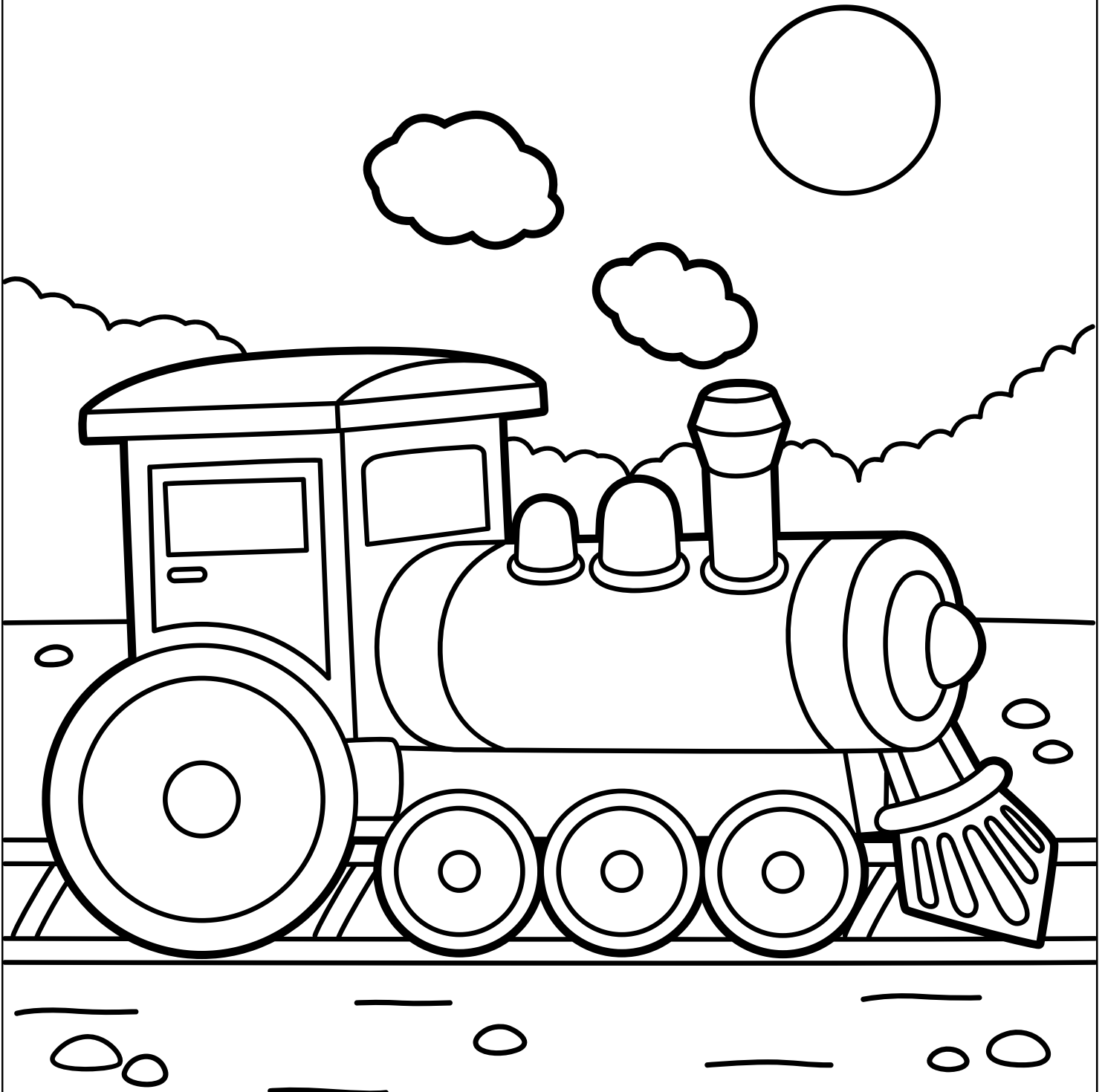

QUEBRA-CABEÇA

IMPRIMA O DESENHO, COLE PALITO DE SORVETE ATRÁS,
RECORTE NAS LINHAS E DEPOIS BRINQUE DE MONTAR O TREM.

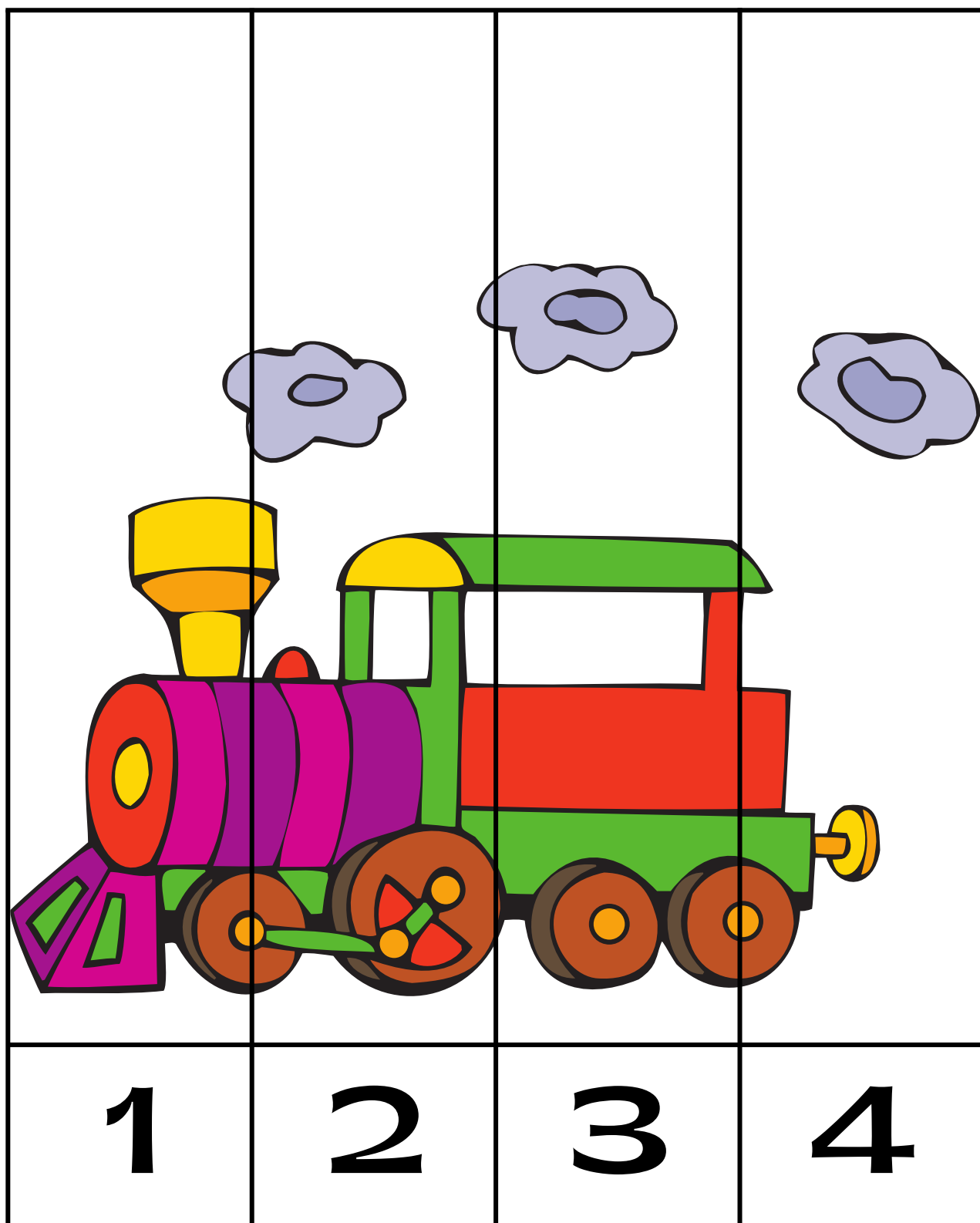

USO DA TESOURA

RECORTE OS TRAÇOS ABAIXO DO TREM E PARE EM CIMA DO CÍRCULO PRETO.



LABIRINTO

AJUDE O TRENZINHO A LOCALIZAR A ESTAÇÃO
PASSANDO PELO LABIRINTO.

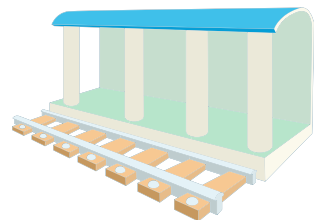
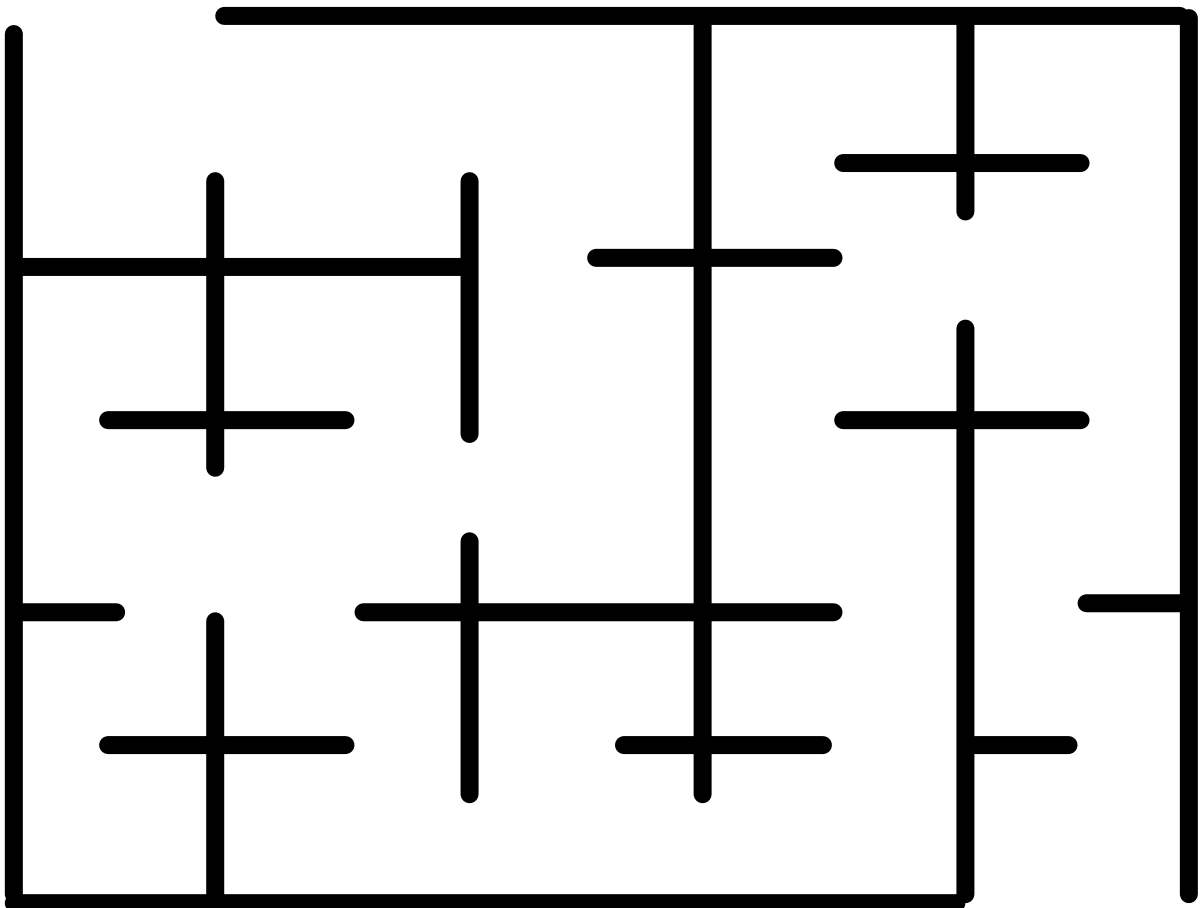

TREM DO ALFABETO

ESCREVA AS LETRAS
DO ALFABETO EM
ORDEM. UMA EM CADA
VAGÃO.

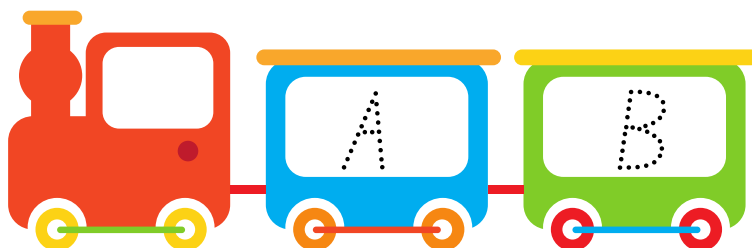

TREM

COMPLETE O PONTO A PONTO E PINTE O VEÍCULO :

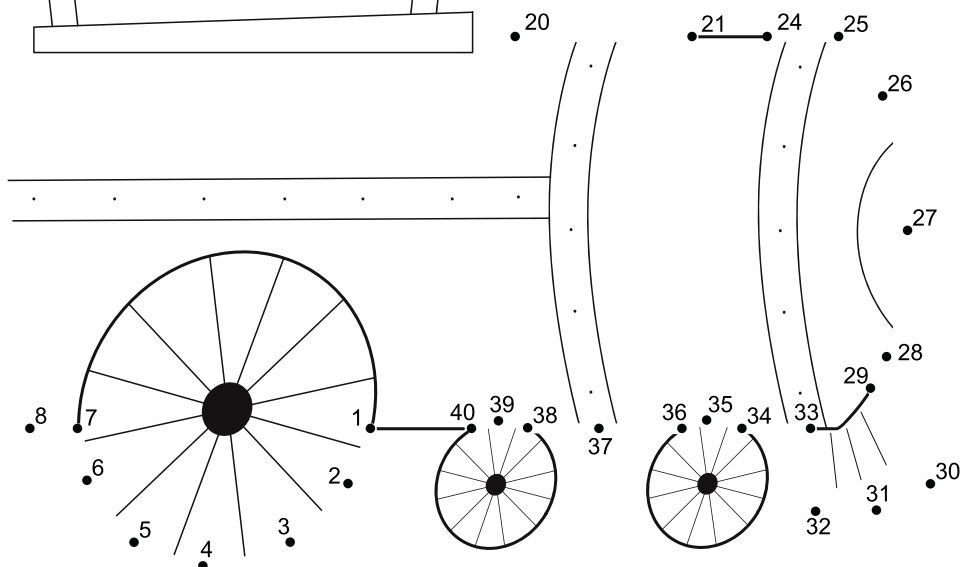
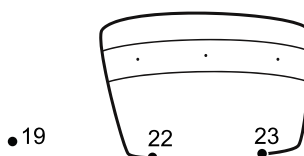
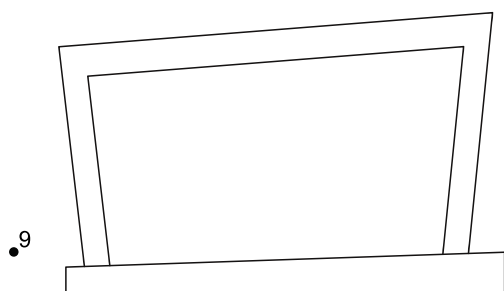
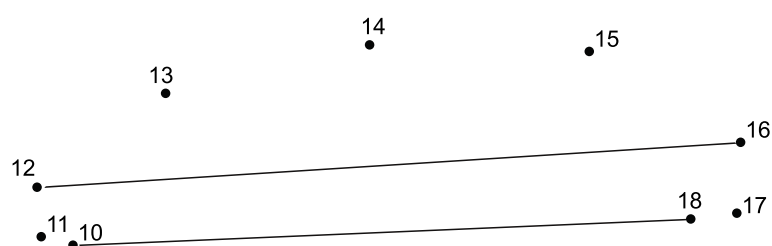
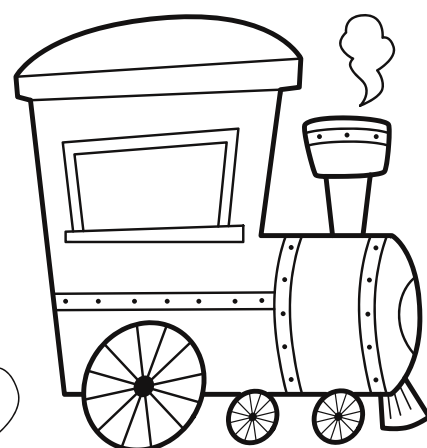



ORDEM CRESCENTE

- COPIE OS NÚMEROS NOS VAGÕES EM ORDEM CRESCENTE.

~~7~~ 19 11 24 15 ~~6~~ 22

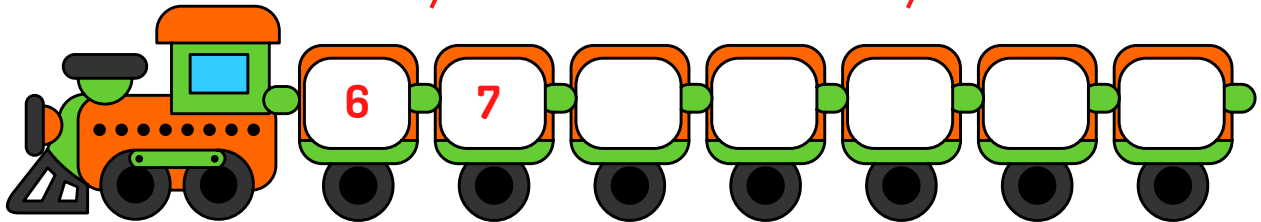

18 21 2 13 29 11 23

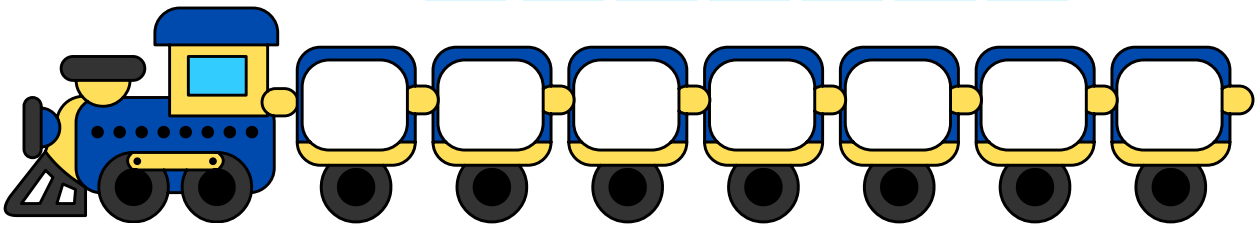

25 7 27 14 21 10 18

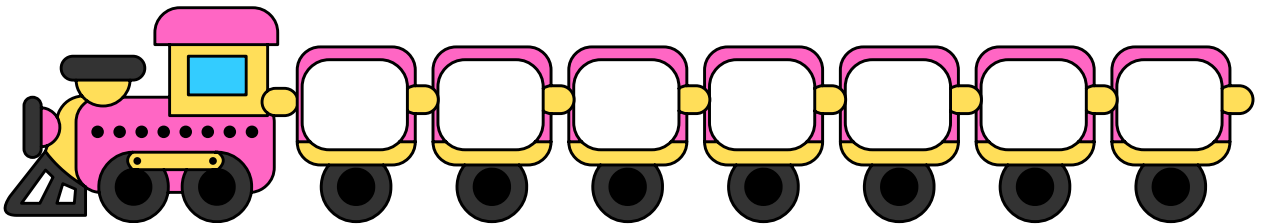

6 24 19 2 13 22 17

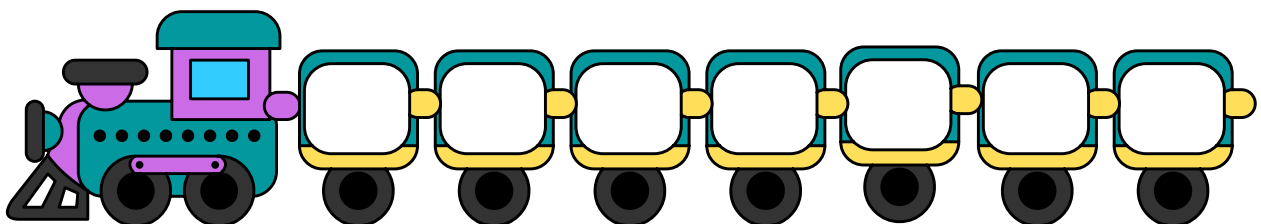

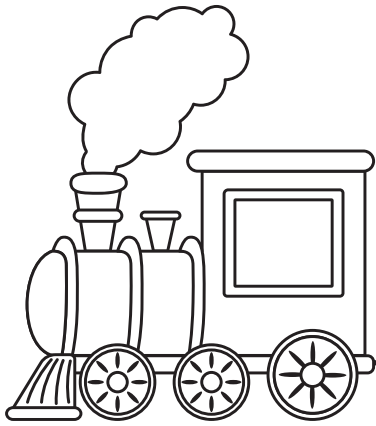

ORDEM DECRESCENTE

COLOQUE OS NÚMEROS NA ORDEM DECRESCENTE.

8, 1, 4, 10

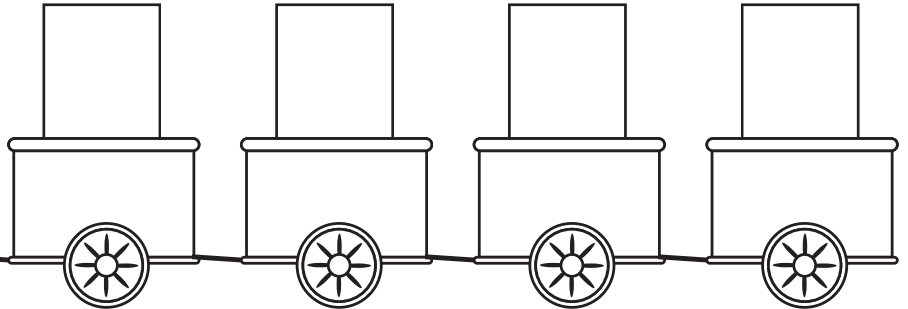

13, 7, 12, 3

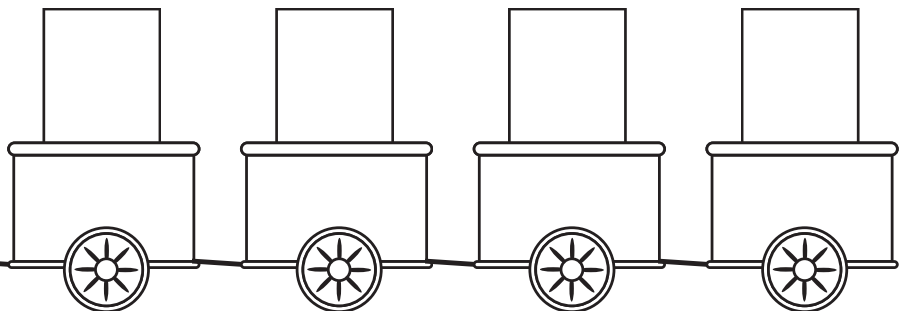

23, 27, 9, 17

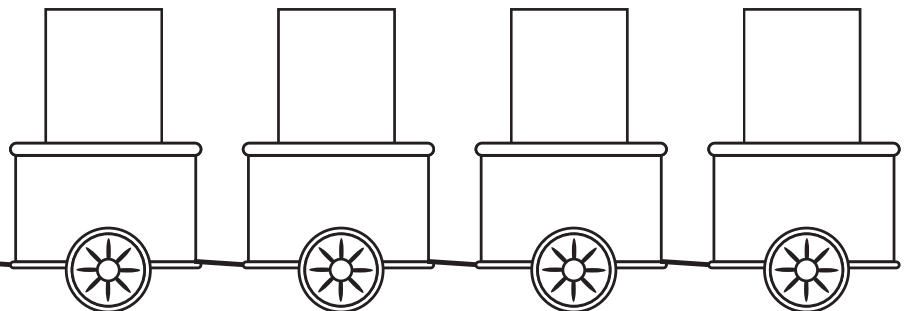

45, 6, 18, 44

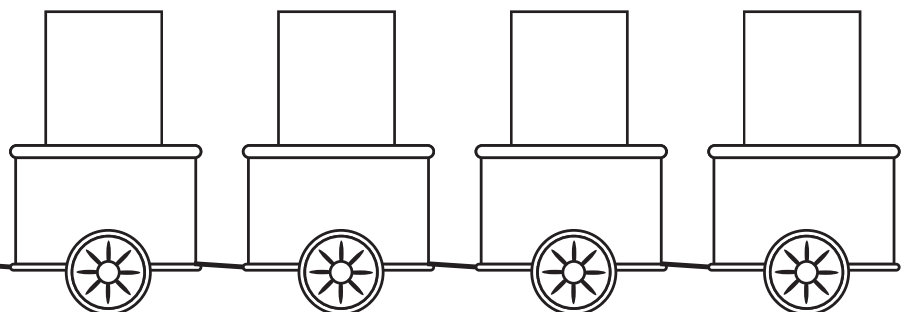

PALAVRAS QUE COMEÇAM COM...

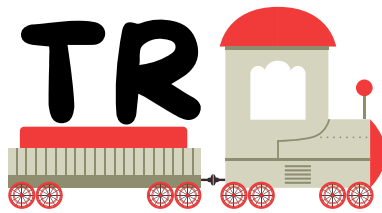

ESCREVA OS NOMES DAS PALAVRAS QUE COMEÇAM COM "TR" AO LADO DA IMAGEM CORRESPONDENTE:

TREM

TRISTE

TRÊS

TRATOR

TRAVE



3



SOBRE A CANTIGA “PIUÍ ABACAXI”, RESPONDA:

1) NA CANTIGA, O QUE RIMA COM “PIUÍ”?

2) QUAL É O MEIO DE TRANSPORTE QUE FAZ “PIUÍ”?

3) SEGUNDO A CANTIGA, POR QUE DEVEMOS OLHAR PARA O CHÃO?

4) QUEM NÃO GOSTA QUANDO A CRIANÇA SE MACHUCA?

5) FAÇA UM DESENHO PARA REPRESENTAR A CANTIGA ESTUDADA.



Gostou?

Apoie-nos a continuar produzindo material gratuito de qualidade fazendo um PIX e-mail de qualquer valor para mardoconhecimento@gmail.com

E siga-nos nas redes sociais, clicando nos ícones a seguir.





LOJA DO MAR DO CONHECIMENTO



clique na capa do produto
para fazer sua compra

